

Designed to speed up production In Wet & Harsh environments



Easy to clean

All terminal platform combinations are designed after latest hygienic design guidelines for fast and thorough cleaning procedures.



Sharp, clear, easy to read

The content of the displays is configurable and show exactly what you need to know. Due to three selectable display modes different parameters are shown. The large LC Display facilitates clear and comfortable data reading.



colorWeight® for speed and clarity

The colored backlight of the LC display provides easily readable unmistakable information as to whether or not the weight is within the tolerance limit. Different colors can be configured in the set up menu.



ICS4_9 Combi bench solution Optimize Your Production Processes

Production operators need to be familiar with their weighing systems. This is an important basic requirement to optimize your production. But how can this be achieved as every working place is different?

The new food scale line: ICS429 – ICS439 – ICS449 – ICS469 offers you seamless integration into your production process as your weighing solution will be individually configured for fast and precise operations – exactly according to your needs.

Type of construction



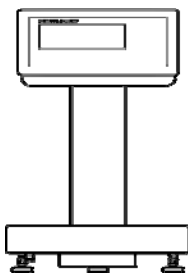

The terminals can individually be mounted in three different ways to the platform. Combined with the right load cell (depends on your individual environment) this solution increases the long term life and the up-time of your scale.



Technical Data



Terminals

- The weights & measures data of ICS devices are shown within the display - not on stickers like in the past. The display indicates if the system is approved or not.
- Double sealed terminals: Longer up times in harsh environments. No need for terminal "double bagging" or to distance terminal from the base.
- The improved hygienic design avoids contamination traps and supports fast and thorough cleaning.
- With IP69k protection, the terminal withstands even the harshest pressure cleaning procedures.
- The smart weighing counter helps our technical staff to determine how the scale is treated in your environment and what measures are needed to keep the scale in a perfect shape.
- Choose your well-fitting type of construction (t-, f- or c-version) for your individual ergonomic setup.
- Combi bench solutions are only possible with analogue scale interface.

	ICS429 	ICS439 	ICS449 	ICS469 
Dimension & Type	232x132x115 mm / 9.13x5.2x4.53" Stainless steel 1.4301 or AISI 304			
Display	LCD liquid crystal graphical display, with backlighting			
Character height	Default layout = 19 mm Big font mode = 26 mm 3-line info mode = 15 mm			
Keypad	Tactile-touch membrane keypad (PET) Scratch-resistant material			
Numeric keypad	No	Yes	No	Yes
Keystrokes	> 1.000.000			
Mains connection	100 – 240 V / 50 – 60 Hz / 300 mA Power cord approx. 2.5m			
Battery	12 V / 2.5 A 1 strain gauge weighing cell continuous operation ~ 15h (depends also on which data interfaces are assembled) Life time: 500 to 1,000 charging/discharging cycles			
Temperature range	Class III -10 – 40 °C / 14 – 104 °F Class II 0 – 40 °C / 32 – 104 °F			
Humidity	Max. rel. humidity 85 % for temperatures up to 40 °C			
Data interfaces	Standard: RS232 plus 1 additional data interface: RS232, RS422/485, USB device, Ethernet			
Analogue scale connection	Impedance: $\geq 80 \Omega$ Excitation: 3,3 V Sensitivity: 2 to 3 mV/V Max. Resolution: 7500e (OIML), 300.000d (non approvable) Min. verification interval: 0,5 $\mu\text{V/e}$			
Approvals	OIML, NTEP, IP66, IP68, IP69k, CE, CSA C US			
Application/Features	Basic weighing, Average weighing / 3 different display layouts		Basic weighing, Average weighing, Simple counting, Over-Under checkweighing / 3 different display layouts, data storage	

Technical Data

Terminal platform combinations

Type of construction	t-version	c-version	f-version
			
	Terminal and platform are connected by cable. Suitable for wall mount or desk operation.	Terminal and column are seamlessly welded together. Cables are laid inside of the column.	Terminal is fix mounted in front of the platform. Suitable for desk operation.
	---	Indicator is always installed on the short side of the platform	Indicator is always installed on the short side of the platform
Weighing ranges	3, 6, 15, 30, 60 kg 5, 10, 25, 50, 100 lb	3, 6, 15, 30, 60 kg 5, 10, 25, 50, 100 lb	3, 6, 15, 30, 60 kg 5, 10, 25, 50, 100 lb
Platform sizes	A, BB, B, QA, QB	A, BB, QA, QB Not available with B-size platforms	A, BB, B, QA, QB
Load cells which will be used when t-, f- or c-version will be ordered	Standard: potted aluminium load cell (identical to PBA226 with hygienic kit) IP65 Optional: stainless steel load cell potted (identical to PBA426 with hygienic kit) IP65 & IP67 Optional: stainless steel load cell hermetically sealed (identical to PBA429 with hygienic kit) IP68 & IP69k		
Hygienic kit	This kit consist of specially designed levelling kits (feet) and overload stops: No crevices and dead areas - No place for contamination Avoidance of open threats - Easy-to-Clean		

Length of load cell cable for t-version

Model	potted aluminium load cell	Potted stainless steel load cell	Hermetically sealed stainless steel load cell
A	1m / 3.3 ft	3m / 9.9 ft	3m / 9.9 ft
BB	2m / 6.6 ft	3m / 9.9 ft	3m / 9.9 ft
B	2m / 6.6 ft	3m / 9.9 ft	3m / 9.9 ft
QA	1m / 3.3 ft	3m / 9.9 ft	3m / 9.9 ft
QB	2m / 6.6 ft	3m / 9.9 ft	3m / 9.9 ft

Dimensional drawings

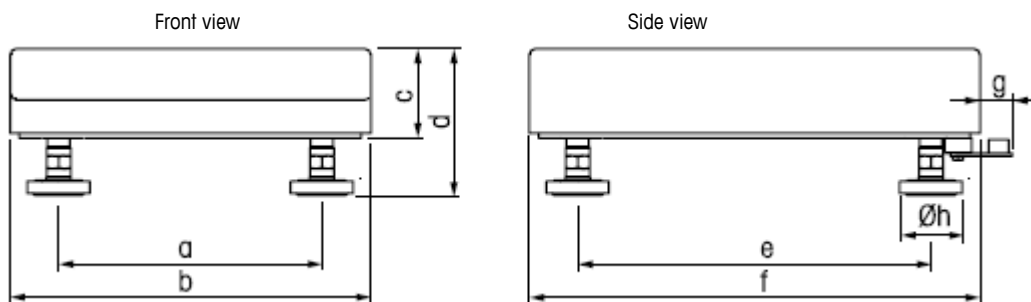

Dimension	A		BB		B		QA		QB	
	[mm]	["]	[mm]	["]	[mm]	["]	[mm]	["]	[mm]	["]
a	175	6,89	235	9,25	335	13,81	163	6,41	240	9,45
b	240	9,45	300	11,81	400	15,74	228	8,97	305	12,00
c	59	2,32	76	2,99	108,5	4,27	59	2,32	76	2,99
d	97	3,81	108	4,25	134,5	5,29	97	3,81	108	4,25
e	235	9,25	335	13,81	435	17,12	163	6,41	254	10,0
f	300	11,81	400	15,74	500	19,68	228	8,97	305	12,00
g	21	0,83	18	0,70	18	0,70	21	0,83	17	0,67
h	42	1,65	42	1,65	42	1,65	42	1,65	42	1,65

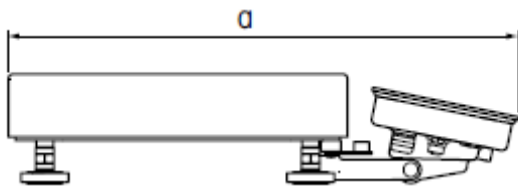

Dimension	A		BB		B		QA		QB	
	[mm]	[°]	[mm]	[°]	[mm]	[°]	[mm]	[°]	[mm]	[°]
a	452	17.80	549	21.61	649	25.55	380	14.96	452	17.80

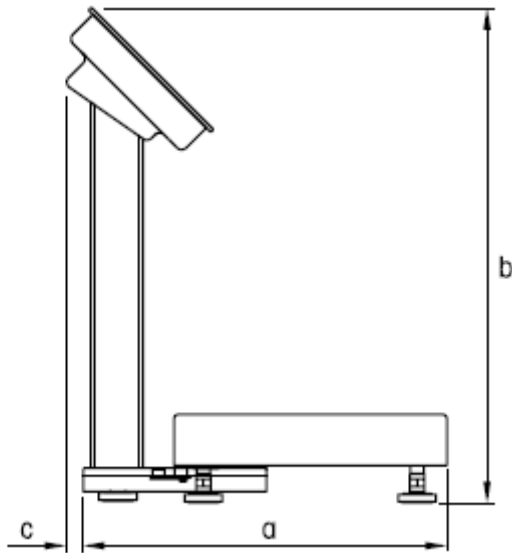
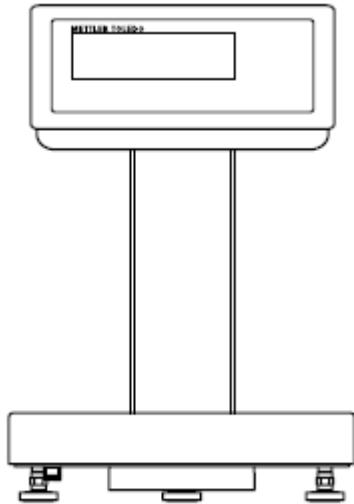

Dimension	A		BB		QA		QB	
	[mm]	[°]	[mm]	[°]	[mm]	[°]	[mm]	[°]
a	452	17.80	515	20.28	347	13.66	419	16.50
b	386	15.20	386	15.20	386	15.20	386	15.20
c	13	0.51	13	0.51	13	0.51	13	0.51

Mettler-Toledo (Albstadt) GmbH

U.d. Malesfelsen 34

72485 Albstadt

Germany

Phone +49 7431 14 0

Fax +49 7431 14 2 32

Subject to technical changes

© 07/2011 Mettler-Toledo AG

www.mt.com/over-under-checkweighers